

LDMOS RF Power Field Effect Transistor

10 W, 1805–1880 MHz, 1930–1990 MHz

10 W, 2110–2170 MHz

Description

The PTF180101 is a 10 W, internally-matched *GOLDMOS* FET device intended for EDGE applications in the DCS/PCS band. Full gold metallization ensures excellent device lifetime and reliability.

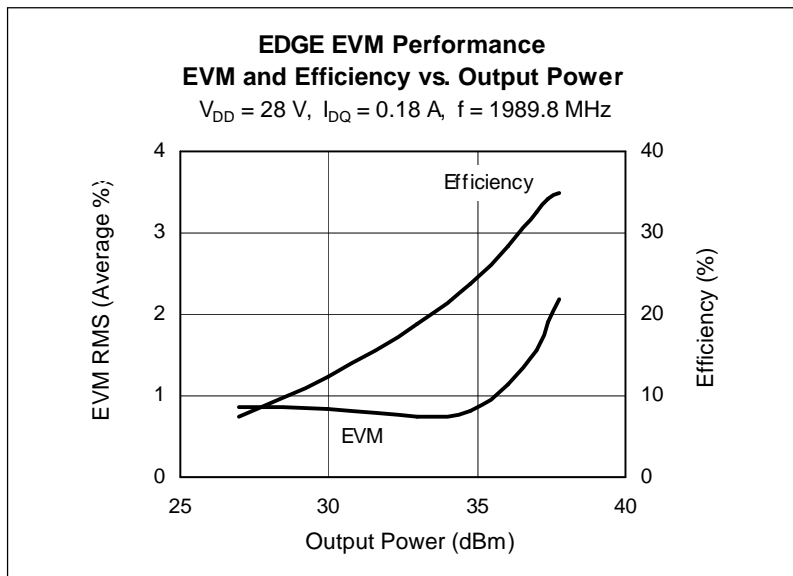

Features

- Typical EDGE performance
 - Average output power = 4.0 W
 - Gain = 19.0 dB
 - Efficiency = 28%
 - EVM = 1.1 %
- Typical WCDMA performance
 - Average output power = 1.8 W
 - Gain = 18.0 dB
 - Efficiency = 20%
 - ACPR = -45 dBc
- Typical CW performance
 - Output power at P-1dB = 15 W
 - Efficiency = 50%
- Integrated ESD protection: Human Body Model Class 1 (minimum)
- Excellent thermal stability
- Low HCI drift
- Capable of handling 10:1 VSWR @ 28 V, 10 W (CW) output power

PTF180101S
 Package 32259



ESD: Electrostatic discharge sensitive device — observe handling precautions!

RF Characteristics, EDGE Operation at $T_{CASE} = 25^{\circ}\text{C}$ unless otherwise indicated

EDGE Measurements (not subject to production test—verified by design/characterization in Infineon test fixture)

$V_{DD} = 28\text{ V}$, $I_{DQ} = 180\text{ mA}$, $P_{OUT} = 4\text{ W}$, $f = 1989.8\text{ MHz}$

Characteristic	Symbol	Min	Typ	Max	Units
Error Vector Magnitude	EVM (RMS)	—	1.1	—	%
Modulation Spectrum @ 400 kHz	ACPR	—	-60	—	dBc
Modulation Spectrum @ 600 kHz	ACPR	—	-70	—	dBc
Gain	G_{ps}	—	19	—	dB
Drain Efficiency	η_D	—	28	—	%

Two-Tone Measurements (tested in Infineon test fixture)

$V_{DD} = 28\text{ V}$, $I_{DQ} = 180\text{ mA}$, $P_{OUT} = 10\text{ W PEP}$, $f = 1990\text{ MHz}$, tone spacing = 1 MHz

Characteristic	Symbol	Min	Typ	Max	Units
Gain	G_{ps}	18	19	—	dB
Drain Efficiency	η_D	30	33	—	%
Intermodulation Distortion	IMD	—	-30	-28	dBc

RF Characteristics, WCDMA Operation at $T_{CASE} = 25^{\circ}C$ unless otherwise indicated

WCDMA Measurements (not subject to production test—verified by design/characterization in Infineon test fixture)

 $V_{DD} = 28\text{ V}$, $I_{DQ} = 135\text{ mA}$, $P_{OUT} = 1.8\text{ W}$,

 $f = 2170\text{ MHz}$, 3GPP signal, channel bandwidth = 3.84 MHz, peak/average = 8.7 dB @ 0.01% CCDF

Characteristic	Symbol	Min	Typ	Max	Units
Adjacent Channel Power Ratio	ACPR	—	-45	—	dBc
Gain	G_{ps}	—	18	—	dB
Drain Efficiency	η_D	—	20	—	%

Two-Tone Measurements (not subject to production test—verified by design/characterization in Infineon test fixture)

 $V_{DD} = 28\text{ V}$, $I_{DQ} = 135\text{ mA}$, $P_{OUT} = 10\text{ W PEP}$, $f = 2170\text{ MHz}$, tone spacing = 1 MHz

Characteristic	Symbol	Min	Typ	Max	Units
Gain	G_{ps}	—	18	—	dB
Drain Efficiency @ -30 dBc IM3	η_D	—	37	—	%
Intermodulation Distortion	IMD	—	-30	—	dBc

DC Characteristics at $T_{CASE} = 25^{\circ}C$ unless otherwise indicated

Characteristic	Conditions	Symbol	Min	Typ	Max	Units
Drain-Source Breakdown Voltage	$V_{GS} = 0\text{ V}$, $I_{DS} = 10\text{ }\mu\text{A}$	$V_{(BR)DSS}$	65	—	—	V
Drain Leakage Current	$V_{DS} = 28\text{ V}$, $V_{GS} = 0\text{ V}$	I_{DSS}	—	—	1.0	μA
On-State Resistance	$V_{GS} = 10\text{ V}$, $V_{DS} = 0.1\text{ A}$	$R_{DS(on)}$	—	0.83	—	Ω
Operating Gate Voltage	$V_{DS} = 28\text{ V}$, $I_{DQ} = 180\text{ mA}$	V_{GS}	2.5	3.2	4.0	V
Gate Leakage Current	$V_{GS} = 10\text{ V}$, $V_{DS} = 0\text{ V}$	I_{GSS}	—	—	1.0	μA

Maximum Ratings at $T_{CASE} = 25^{\circ}C$ unless otherwise indicated

Parameter	Symbol	Value	Unit
Drain-Source Voltage	V_{DSS}	65	V
Gate-Source Voltage	V_{GS}	-0.5 to +12	V
Junction Temperature	T_J	200	$^{\circ}C$
Total Device Dissipation	P_D	58	W
Above 25 $^{\circ}C$ derate by		0.333	W/ $^{\circ}C$
Storage Temperature Range	T_{STG}	-40 to +150	$^{\circ}C$
Thermal Resistance ($T_{CASE} = 70^{\circ}C$, 10 W CW)	$R_{\theta JC}$	3.0	$^{\circ}C/W$

Typical Performance measurements taken in broadband test fixture

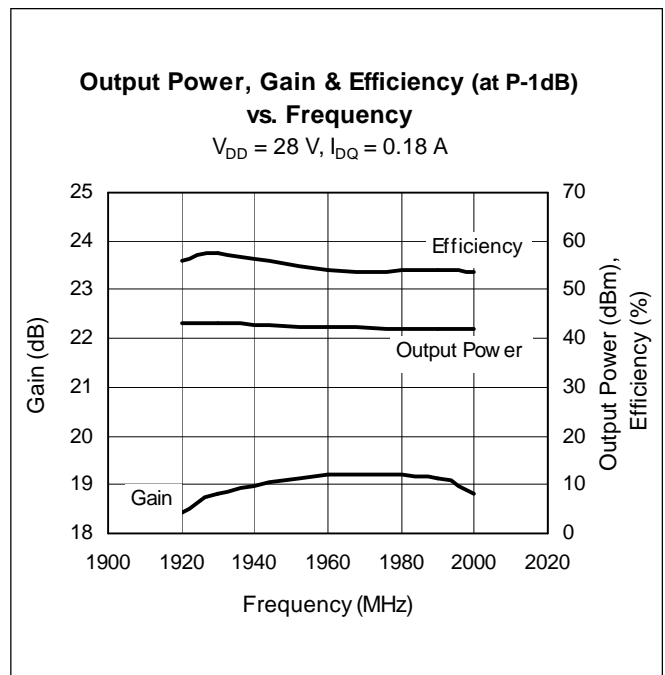
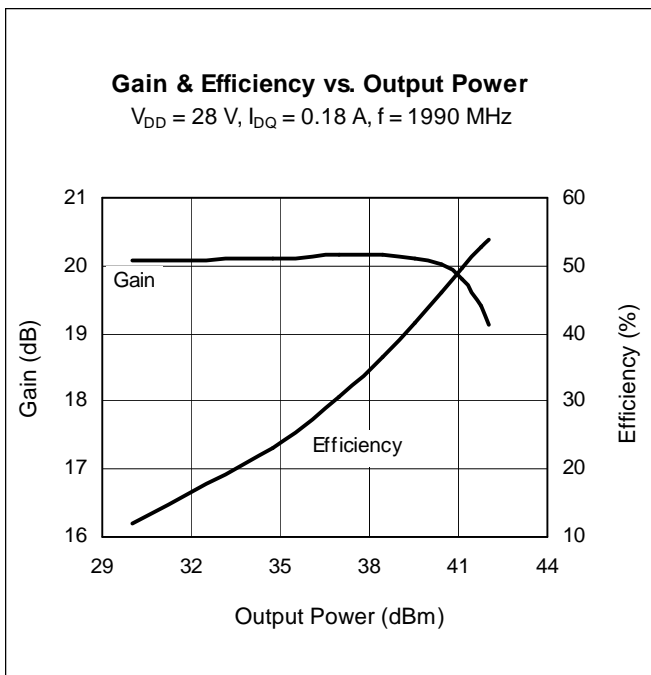
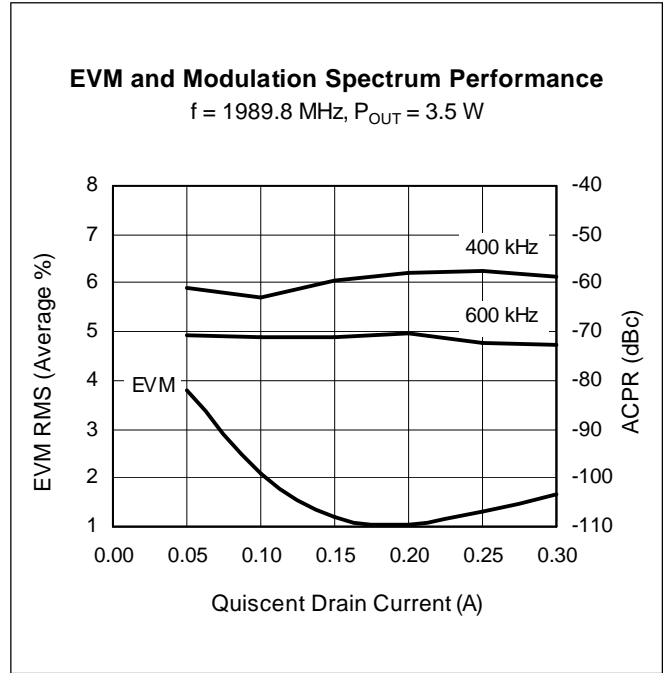
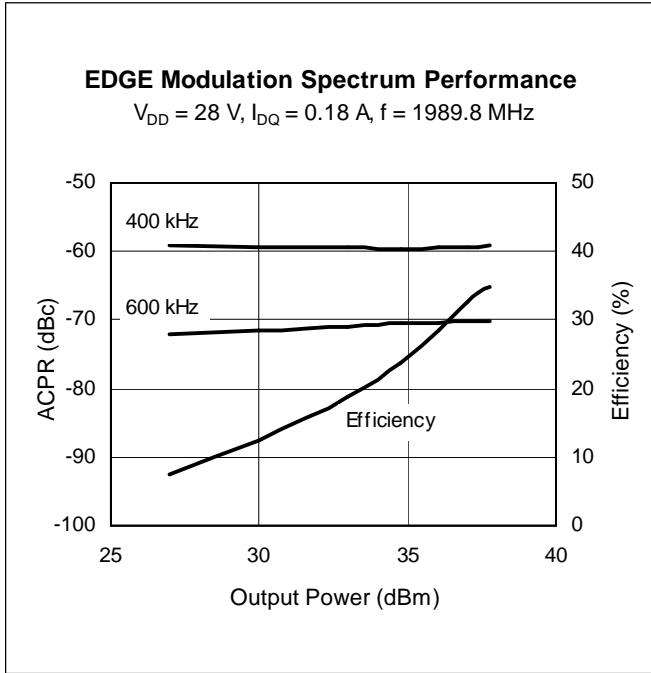

Typical Performance (cont.)

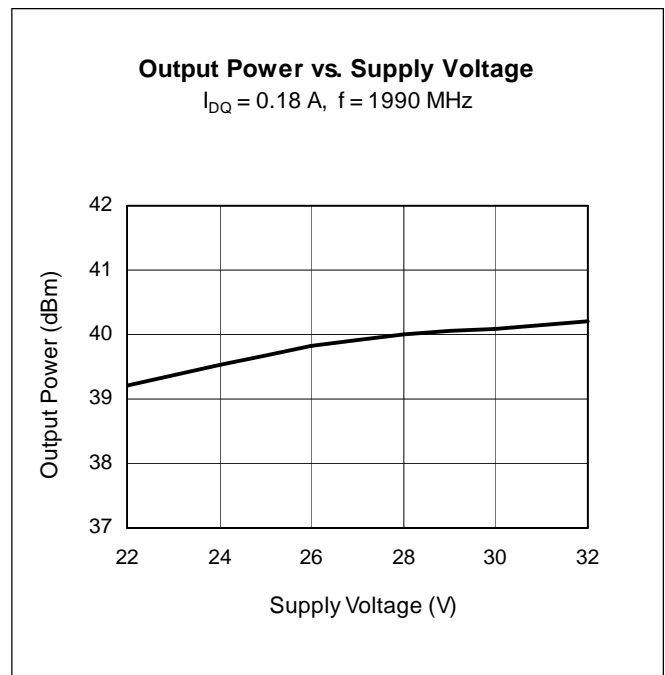
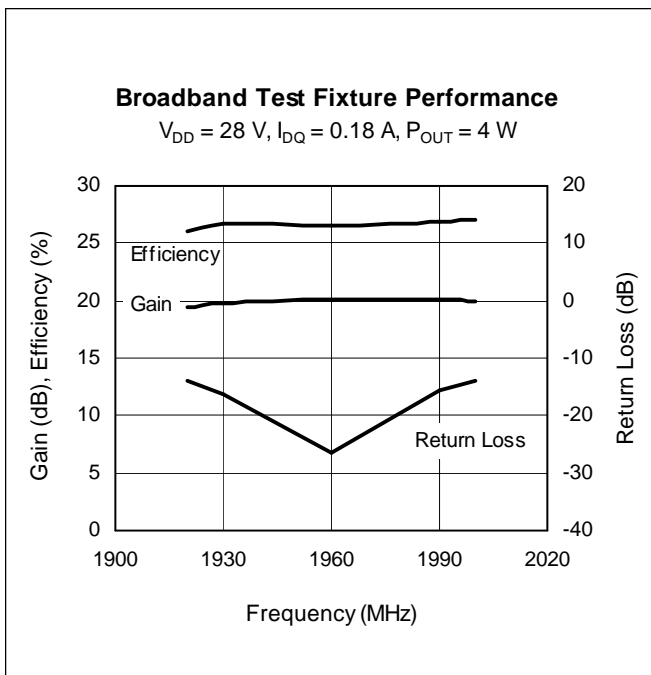
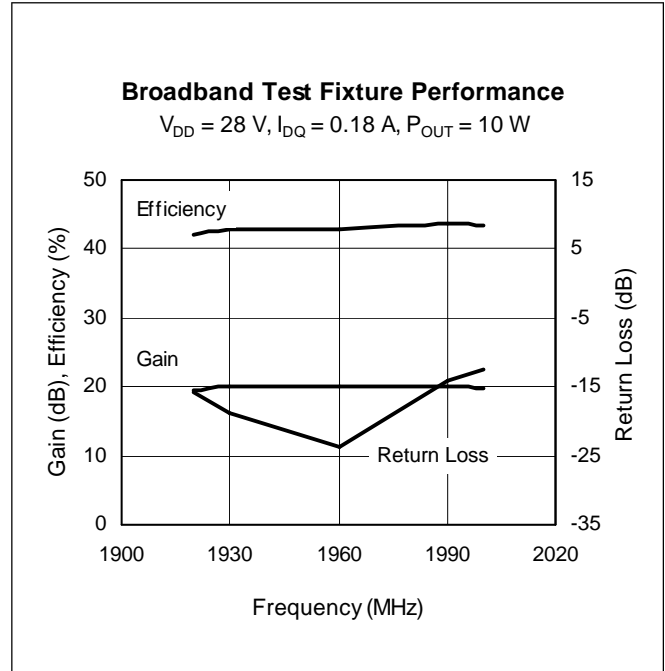
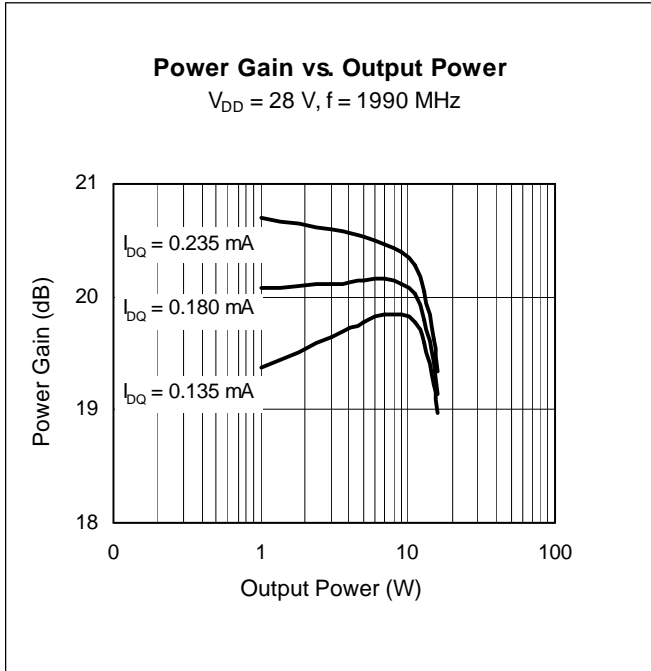

Typical Performance (cont.)

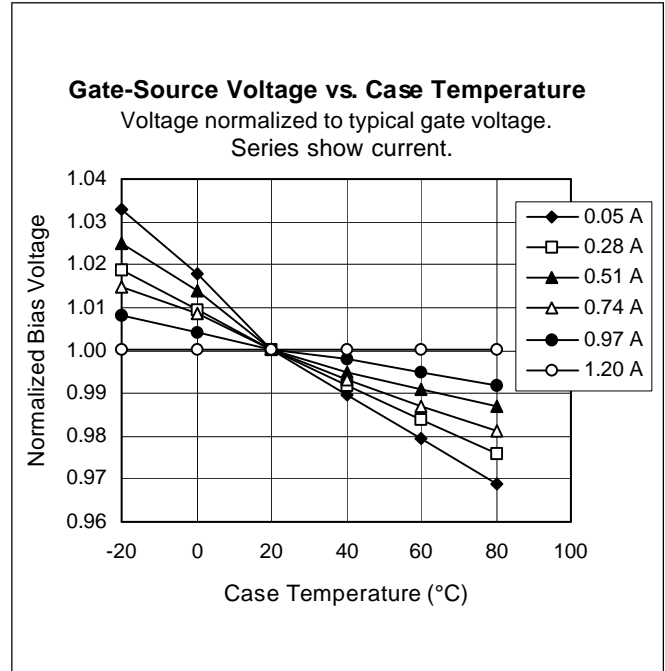
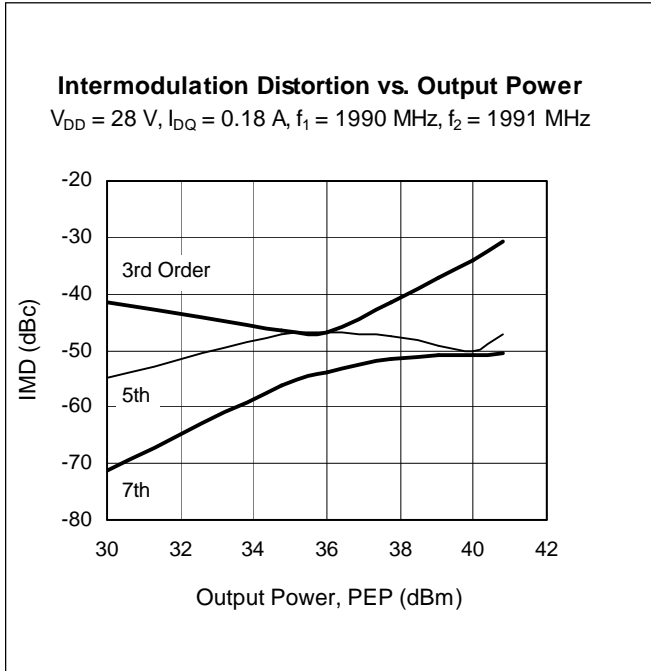

Typical Performance, WCDMA Operation

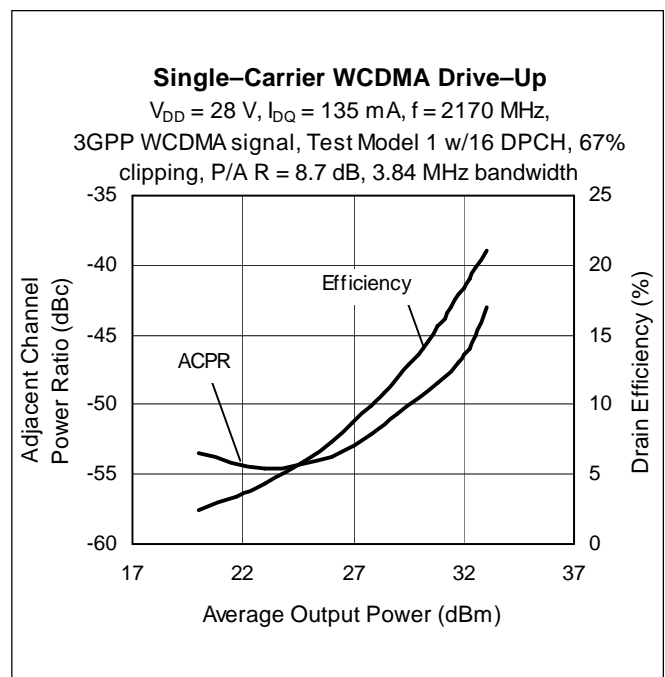
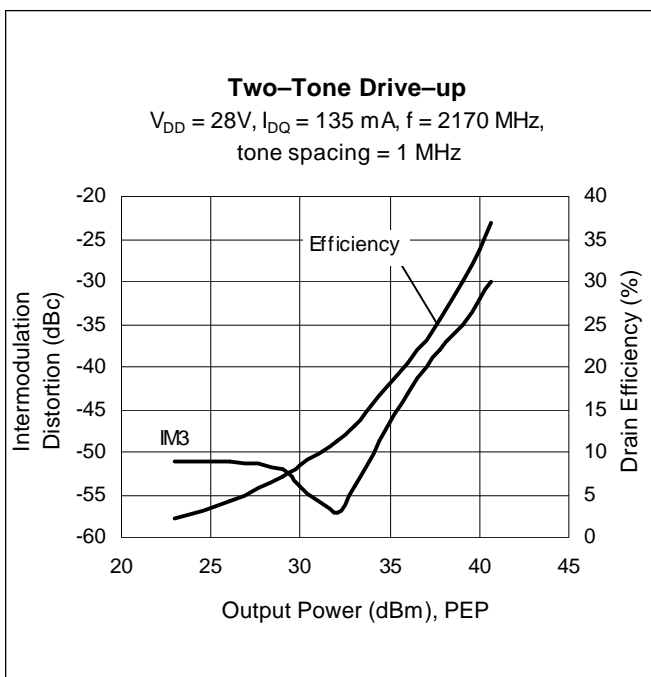

Broadband Circuit Impedance Data

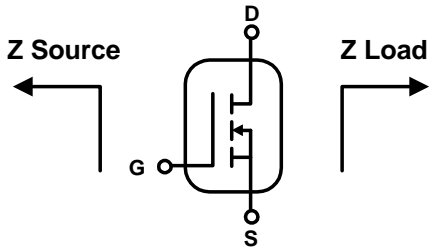

Frequency MHz	Z Source Ω		Z Load Ω	
	R	jX	R	jX
1920	7.3	-2.3	4.6	2.4
1930	8.1	-2.2	4.6	2.5
1960	8.3	-2.6	4.5	2.6
1990	6.5	-4.1	4.5	2.5
2000	6.3	-4.0	4.5	2.5
2020	6.2	-3.7	4.6	2.5

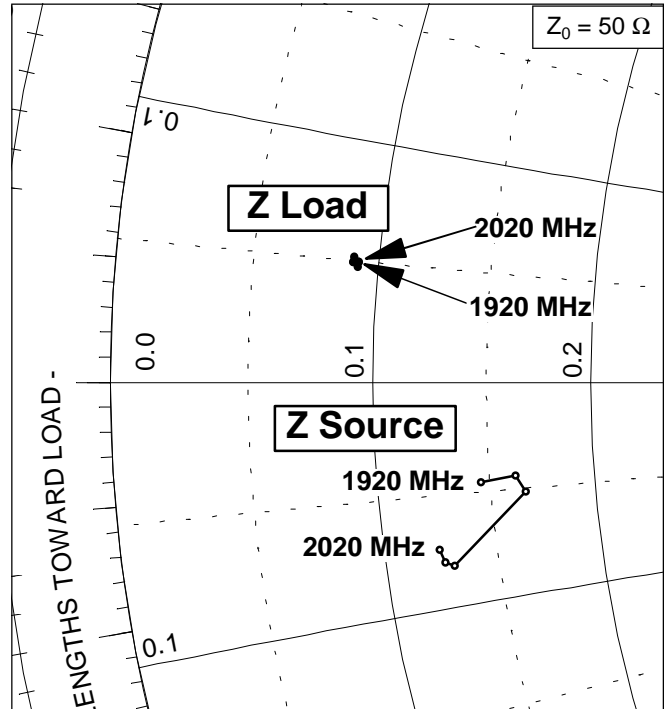

Reference Circuits

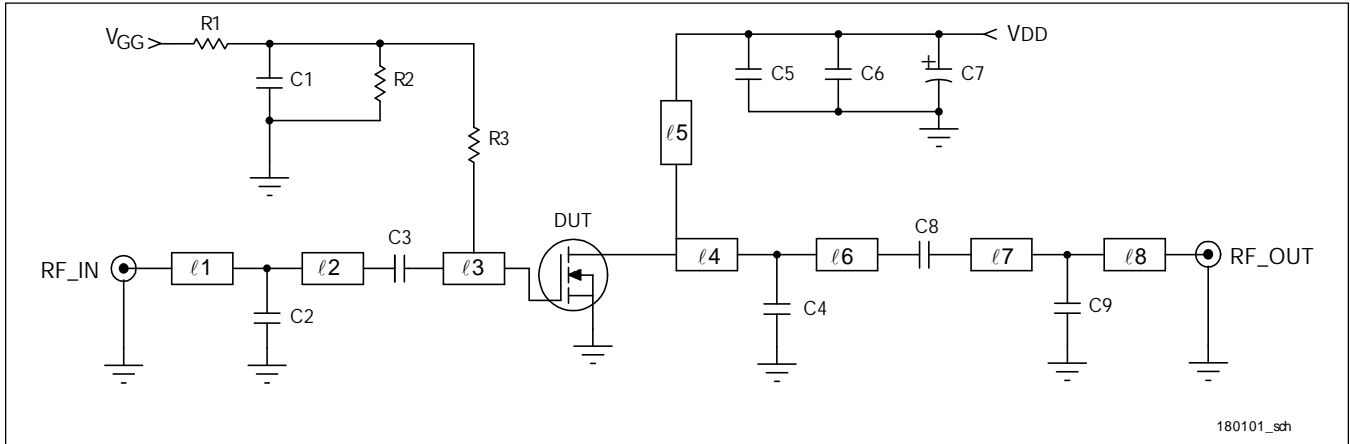

Reference Circuit Schematic

Circuit Assembly Information

DUT	PTF180101	LDMOS Transistor	
Circuit Board	0.76 mm [.030"] thick, $\epsilon_r = 4.5$	Rogers TMM4, 2 oz. Copper	

Microstrip	Electrical Characteristics at 1990 MHz	Dimensions: L x W (mm)	Dimensions: L x W (in.)
ℓ_1	0.133 λ , 50 Ω	10.92 x 1.37	0.430 x 0.054
ℓ_2	0.096 λ , 50 Ω	7.87 x 1.37	0.310 x 0.054
ℓ_3	0.155 λ , 9.5 Ω	11.30 x 12.45	0.445 x 0.490
ℓ_4	0.008 λ , 12.8 Ω	0.64 x 8.86	0.025 x 0.349
ℓ_5	0.286 λ , 70 Ω	23.88 x 0.71	0.940 x 0.028
ℓ_6	0.247 λ , 12.8 Ω	18.29 x 8.86	0.720 x 0.349
ℓ_7	0.145 λ , 50 Ω	11.81 x 1.37	0.465 x 0.054
ℓ_8	0.008 λ , 50 Ω	0.64 x 1.37	0.025 x 0.054

Reference Circuits (cont.)

1930–1990 MHz Operation

Component	Description	Manufacturer	P/N or Comment
C1, C3, C5, C8	Capacitor, 10 pF	ATC	100B 100
C2	Capacitor, 1.7 pF	ATC	100B 1R7
C4	Capacitor, 2.0 pF	ATC	100A 2R0
C6	Capacitor, 0.1 μ F, 50 V	Digi-Key	P4525-ND
C7	Capacitor, 100 μ F, 50 V	Digi-Key	P5182-ND
C9	Capacitor, 0.6 pF	ATC	100A 0R6
R1, R2, R3	Resistor, 220 ohm, 1/4 W	Digi-Key	220QBK

2.11–2.17 GHz Operation

Component	Description	Manufacturer	P/N or Comment
C1, C3, C5, C8	Capacitor, 10 pF	ATC	100B 100
C2	Capacitor, 0.8 pF	ATC	100B 0R8
C4	Capacitor, 2.2 pF	ATC	100A 2R2
C6	Capacitor, 0.1 μ F, 50 V	Digi-Key	P4525-ND
C7	Capacitor, 100 μ F, 50 V	Digi-Key	P5182-ND
C9	Capacitor, 1.0 pF	ATC	100A 1R0
R1, R2, R3	Resistor, 220 ohm, 1/4 W	Digi-Key	220QBK

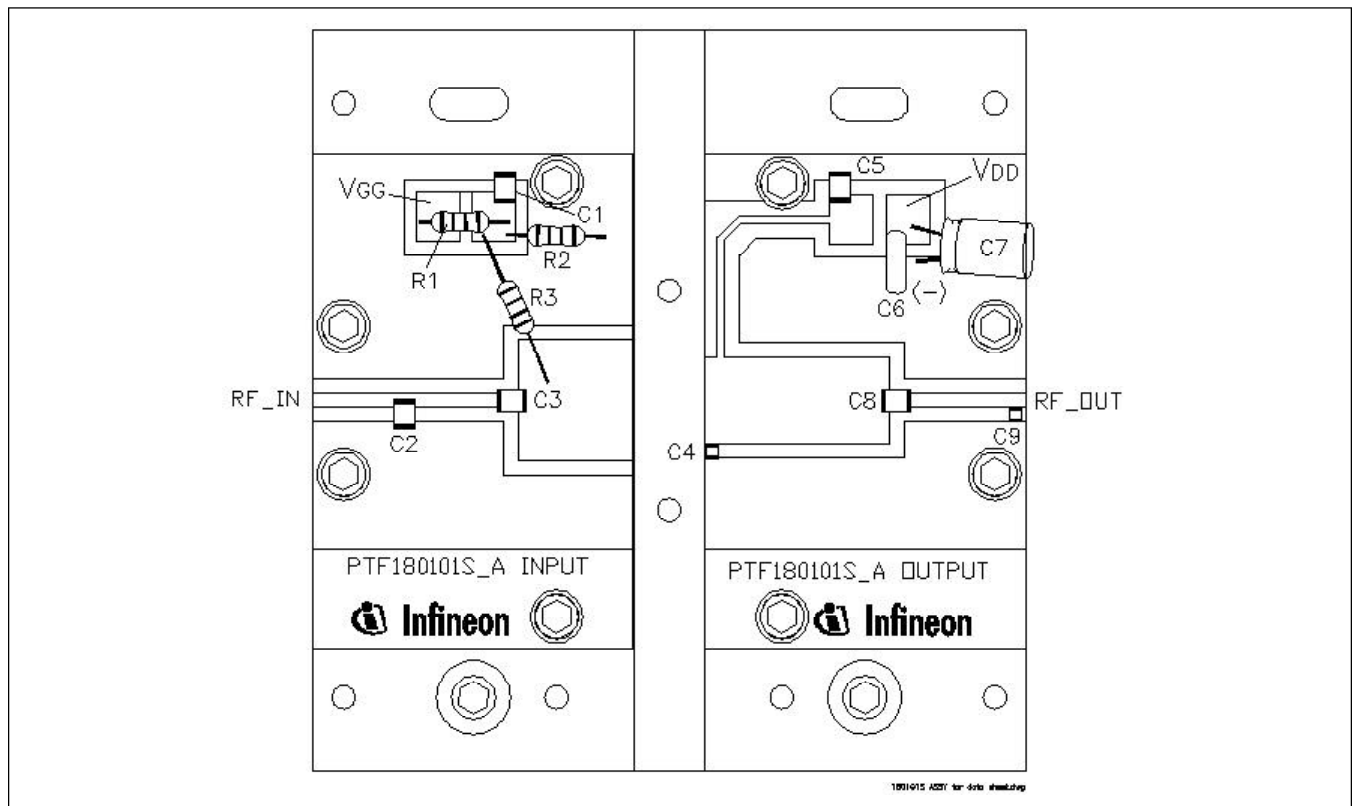

Reference circuit assembly diagram¹ (not to scale)

¹ Gerber files for this circuit are available upon request.

Ordering Information

Type	Package Outline	Package Description	Marking
PTF180101S	32259	Thermally enhanced, surface mount	PTF180101S

Package Outline Specifications

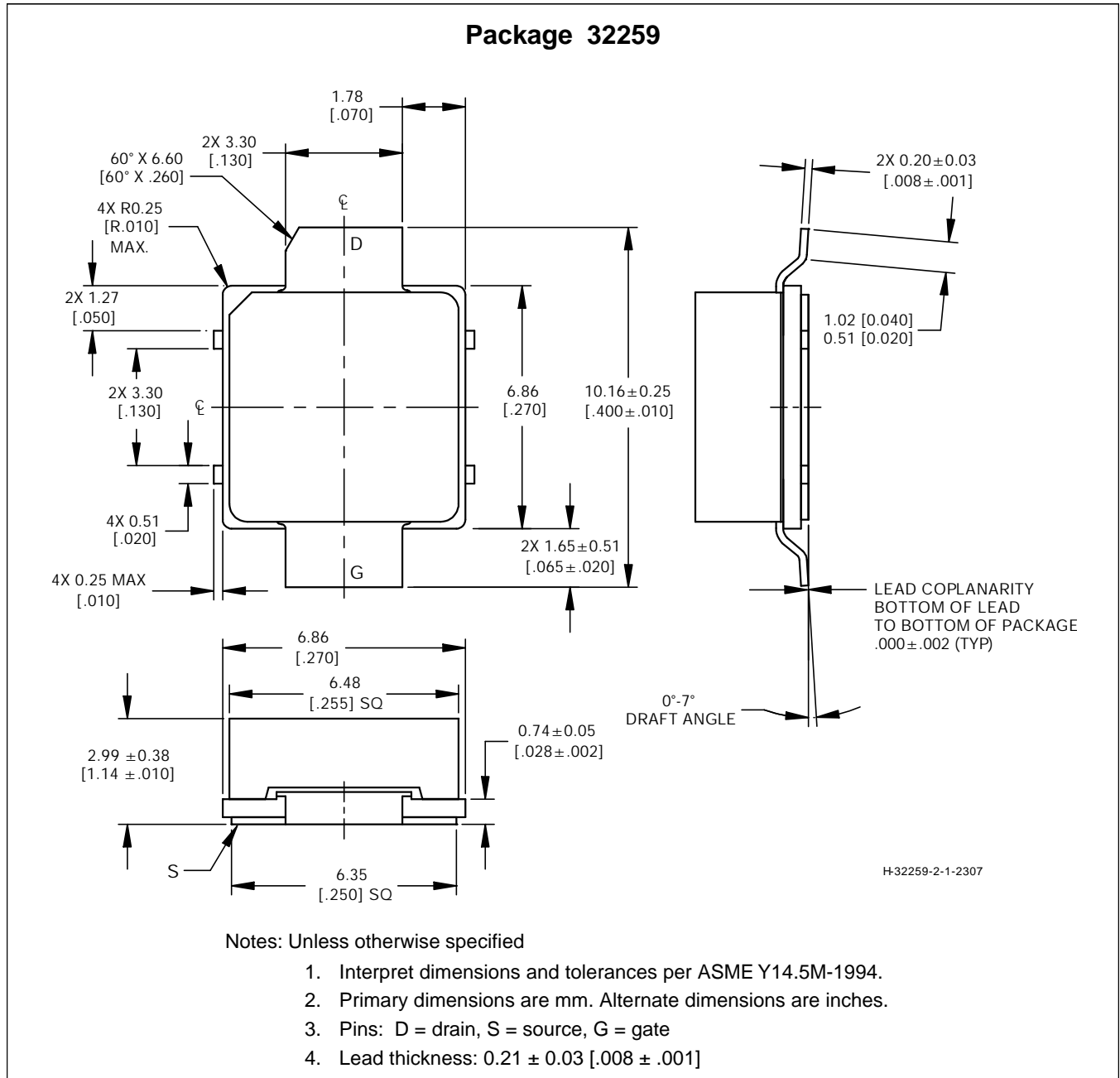

Find the latest and most complete information about products and packaging at the Infineon Internet page <http://www.infineon.com/products>

Previous Version: none

Page	Subjects (major changes since last revision)
1, 5, 7	Add information about WCDMA operation

We Listen to Your Comments

Any information within this document that you feel is wrong, unclear or missing at all?
Your feedback will help us to continuously improve the quality of this document.
Please send your proposal (including a reference to this document) to:

highpowerRF@infineon.com

To request other information, contact us at:
+1 877 465 3667 (1-877-GOLDMOS) USA
or +1 408 776 0600 International

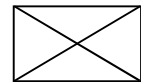
**Edition 2004-02-03**

**Published by Infineon Technologies AG,
St.-Martin-Strasse 53,
81669 München, Germany**

**© Infineon Technologies AG 2003.
All Rights Reserved.**

Attention please!

The information herein is given to describe certain components and shall not be considered as a guarantee of characteristics.
Terms of delivery and rights to technical change reserved.

We hereby disclaim any and all warranties, including but not limited to warranties of non-infringement, regarding circuits, descriptions and charts stated herein.

Information

For further information on technology, delivery terms and conditions and prices please contact your nearest Infineon Technologies Office (www.infineon.com/rfpower).

Warnings

Due to technical requirements components may contain dangerous substances. For information on the types in question please contact your nearest Infineon Technologies Office.

Infineon Technologies Components may only be used in life-support devices or systems with the express written approval of Infineon Technologies, if a failure of such components can reasonably be expected to cause the failure of that life-support device or system, or to affect the safety or effectiveness of that device or system. Life support devices or systems are intended to be implanted in the human body, or to support and/or maintain and sustain and/or protect human life. If they fail, it is reasonable to assume that the health of the user or other persons may be endangered.